

User's Manual

VF770

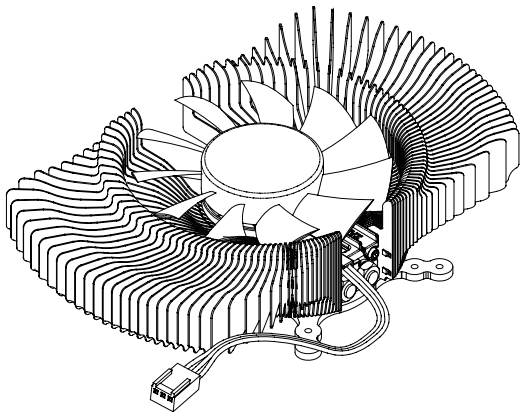

To ensure safe and easy installation,
please read the following precautions.

<http://www.zalman.com>

1. Precautions

- 1) By installing this product on a VGA (Video Graphics Array) card, one PCI slot adjacent to the PCIe (or AGP) slot occupied by the VF770 will become unusable.
- 2) If this product is to be installed on a recently released VGA card, please check for compatibility at Zalman's website first.
- 3) The product CANNOT be installed on Matrox VGA cards, NVIDIA PCX 5***, NVIDIA Geforce 6600/7600/7900 AGP Series, and ATI Radeon 9550/9600 Series.
- 4) If the VGA card and/or its components interfere with the installation of this product, then stop the installation, refer to the list of compatible VGA cards or motherboards at Zalman's website, and install this product with one of the compatible VGA cards or motherboards.
- 5) Do not ingest the Thermal Grease, and avoid its contact with skin and eyes. If contact is made with skin, wash off with water. If ingested or any irritation persists, seek medical attention.
- 6) To prevent possible injuries, gloves must be worn while handling this product.
- 7) Excessive force exerted on the fan may cause damage to the fan and/or system.
- 8) Please keep out of reach of children.
- 9) Check the components list and condition of the product before installation. If any problem is found, contact the retailer to obtain a replacement.
- 10) During transportation of the system, the cooler must be removed. Zalman is not responsible for any damages that occur during the transport of a system.
- 11) Product design and specifications may be revised to improve quality and performance.

Disclaimer) Zalman Tech Co., Ltd. is not responsible for any damages due to external causes, including but not limited to, improper use, problems with electrical power, accident, neglect, alteration, repair, improper installation, or improper testing.

2. Specifications

Model		VF770
Spec.		
Material	Pure Aluminum	
Weight	160g	
Dimensions	150(L) X 85(W) X 31(H)mm	
Fan	Bearing	2 Ball-Bearing
	Dimensions	80(L) X 80(W) X 15(H)mm
	RPM	Low Noise Mode: 1,350rpm ± 10% Performance Mode: 2,650rpm ± 10%
	Noise Level	Low Noise Mode: 1,350rpm ± 10% Performance Mode: 2,650rpm ± 10%

3. Components

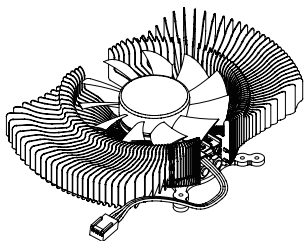

VGA Cooler

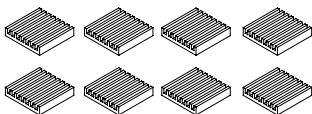

VGA RAM Heatsinks



Thermal Grease



User's Manual

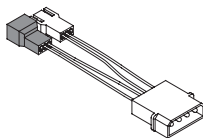

Dual Connector

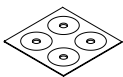

PET Washers

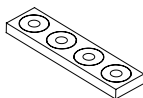

Rubber Washers



Fixing Bolts

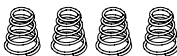

Springs

4. Exploded View

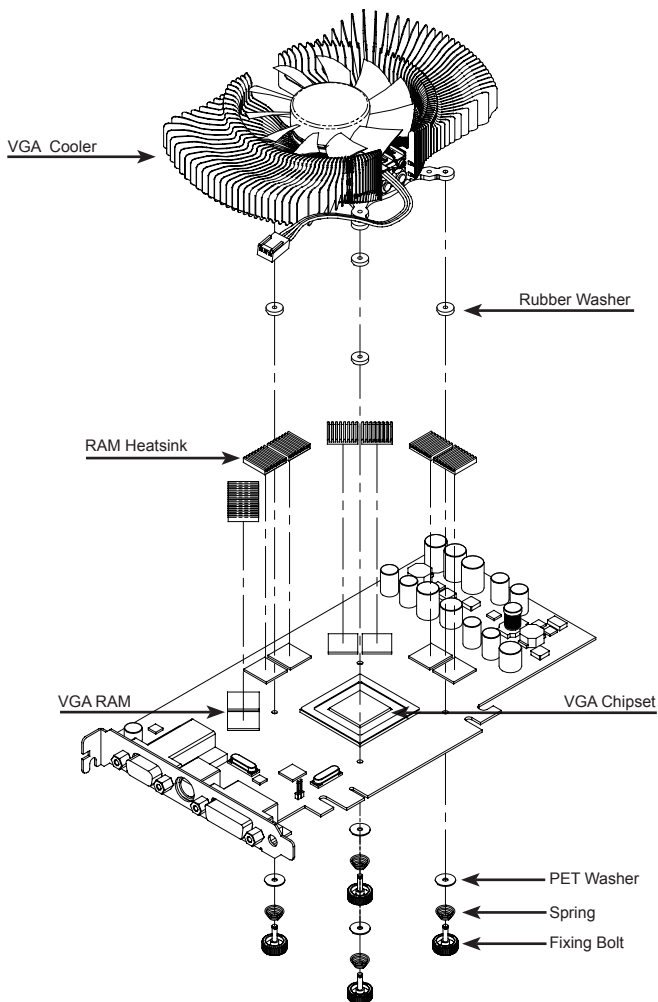

5. Installation

1) VGA RAM Heatsink Attachment

Remove the film from the Thermal Tapes on the bottom of the RAM Heatsinks and attach the Heatsinks on the VGA RAM.

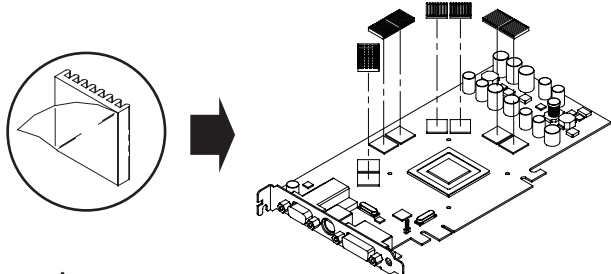

Caution

- ▶ Clean the surface of the RAM with acetone or alcohol before attaching the RAM Heatsinks.
- ▶ The bonding strength of the Thermal Tapes reaches 90% after 24 hours of curing. Do not exert excessive force on the RAM Heatsinks during this period.
- ▶ Thermal Tapes are not reusable because they lose adhesiveness after their initial application. Purchase new Thermal Tapes if the RAM Heatsinks need to be reattached.

2) PET Washer Installation

Remove the PET washer from the PET Washer Sheet and attach to the VGA card's rear installation holes.

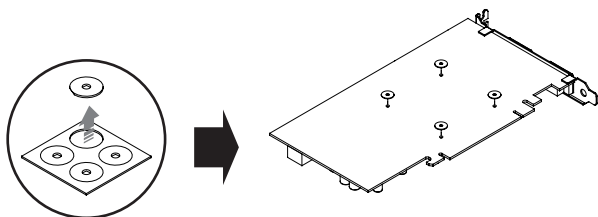

3) Thermal Grease Application

Clean the contact surface of the VGA Chipset completely. Apply a thin and thorough layer of Thermal Grease on the VGA Chipset that makes contact with the base of the VGA Cooler.

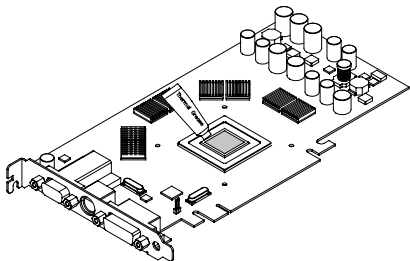

4) Rubber Washer Installation

Determine the appropriate holes for the Rubber Washers from the table below, then align and attach the Rubber Washers to the holes.

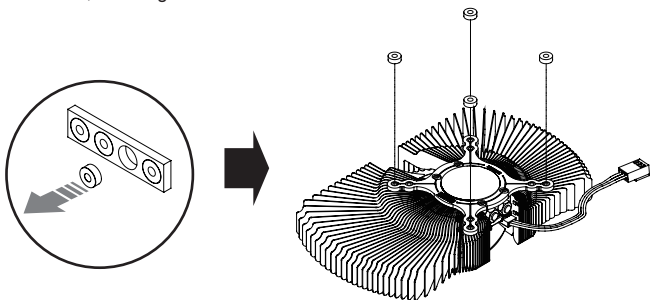

 **Tip**

Installation Holes by VGA Cards

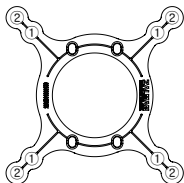

Installation Holes	①	②	
Compatible VGA Cards	ATI Radeon HD4650 Series	ATI Radeon HD4850 Series	NVIDIA GeForce 8600GTS Series
	ATI Radeon HD4670 Series	ATI Radeon HD4830 Series	NVIDIA GeForce 7950GT Series (except 7950GX2)
	ATI Radeon HD3650 Series	ATI Radeon HD3870 Series	NVIDIA GeForce 8600GT Series
	ATI Radeon HD2600 Series	ATI Radeon HD3850 Series	NVIDIA GeForce 7900 Series
	ATI Radeon X1600 Series	ATI Radeon HD2600XT(DDR4)Series	NVIDIA GeForce 7800 Series (except 7800GS)
	ATI Radeon X1650 Series	ATI Radeon X1800XL Series	NVIDIA GeForce 7600 Series
	NVIDIA GeForce 7600 Series	NVIDIA GeForce 9600GT Series	NVIDIA GeForce 7600 Series
	NVIDIA GeForce 6600 Series (except 6600 AGP Series)	NVIDIA GeForce 9600GSO Series	NVIDIA GeForce 7800 Series
		NVIDIA GeForce 9500GT Series	
		NVIDIA GeForce 9400GT Series	

5) Spring Insertion on the Fixing Nut

Install the Spring end with the smaller diameter on the Fixing Nut as shown in the diagram.



6) VGA Cooler Installation

① After installing the Rubber Washers to the cooler, face the VGA card's side with the fan downward, and align with the installation holes.

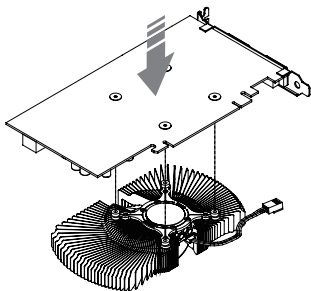

② Use the Spring-installed Fixing Bolts to install the VGA cooler.

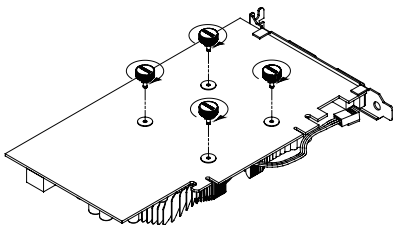

Tip

Please tighten each Fixing Nut one rotation at a time until all are completely tightened.



Caution

- ▶ Make sure the cooler's base is completely in contact with the VGA chipset.
- ▶ Make sure the VGA cooler does not interfere with the VGA card's components.

7) VGA Cooler Installation

Install the VGA card to the slot after installing the cooler.

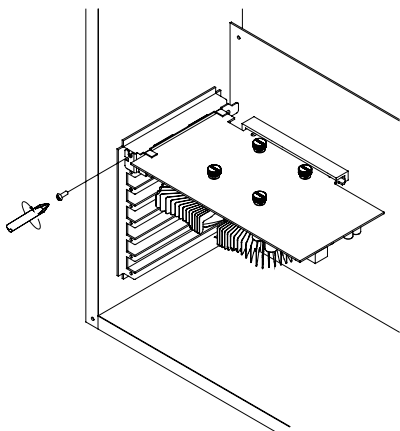

8) Power Supply

Connect the 3-Pin dual connector to the User's performance and noise preference. The Fan RPM can be adjusted according to the 3-Pin Connector's color.

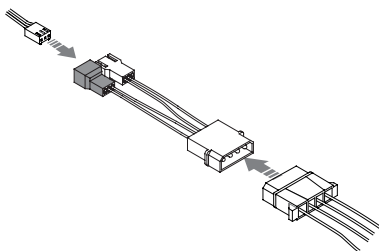

Specs	Low Noise Mode(5V)	Performance Mode(12V)
Color	White	Black
RPM	1,350rpm \pm 10%	2,650rpm \pm 10%
Noise	18.5dB \pm 10%	28.5dB \pm 10%

GS1000 / GS1000SE

- E-ATX / Standard ATX / microATX Compatible
 - * Supports Intel Dual Xeon server motherboards
- UP to 6 Hot Swap HDD Bays
 - * GS1000(3 Standard / 3 Optional)
 - * GS1000 SE(Optional)
- Tool-Free HDD Installation
- Airflow Optimized Design
- Vibration Absorbing HDD Dampers and Feet
- The World's First Roller Rails for Smooth & Easy PSU Installation
- Cable Compartment Behind the Motherboard for Cable Management
- Dedicated Fan Compartment for Fanless PSU Users
- Up to a Total of 8 HDD Bays
 - * 2 Adaptors & Bezels included for use of two 5.25" bays as 3.5" Internal(HDD)/ External(FDD) Bays



GT1000

- High-End Gaming Enclosure Built with Sturdy All Aluminum Panels
- Three Tool-Free Hinged Magnetic Panels (2 Left, 1 Right) for Easy Installation and Access to Components
- Tool-Free Installation of Disk Drives, Fan Controlles, Audio Interfaces etc.
- Accommodates up to 6 Hard Drives
- Luxurious and Cool Aesthetics.
- Color Option: Black (Red LED Fans), Titanium (Blue LED Panel).



For more information, please visit our website.